

.CANESTRO

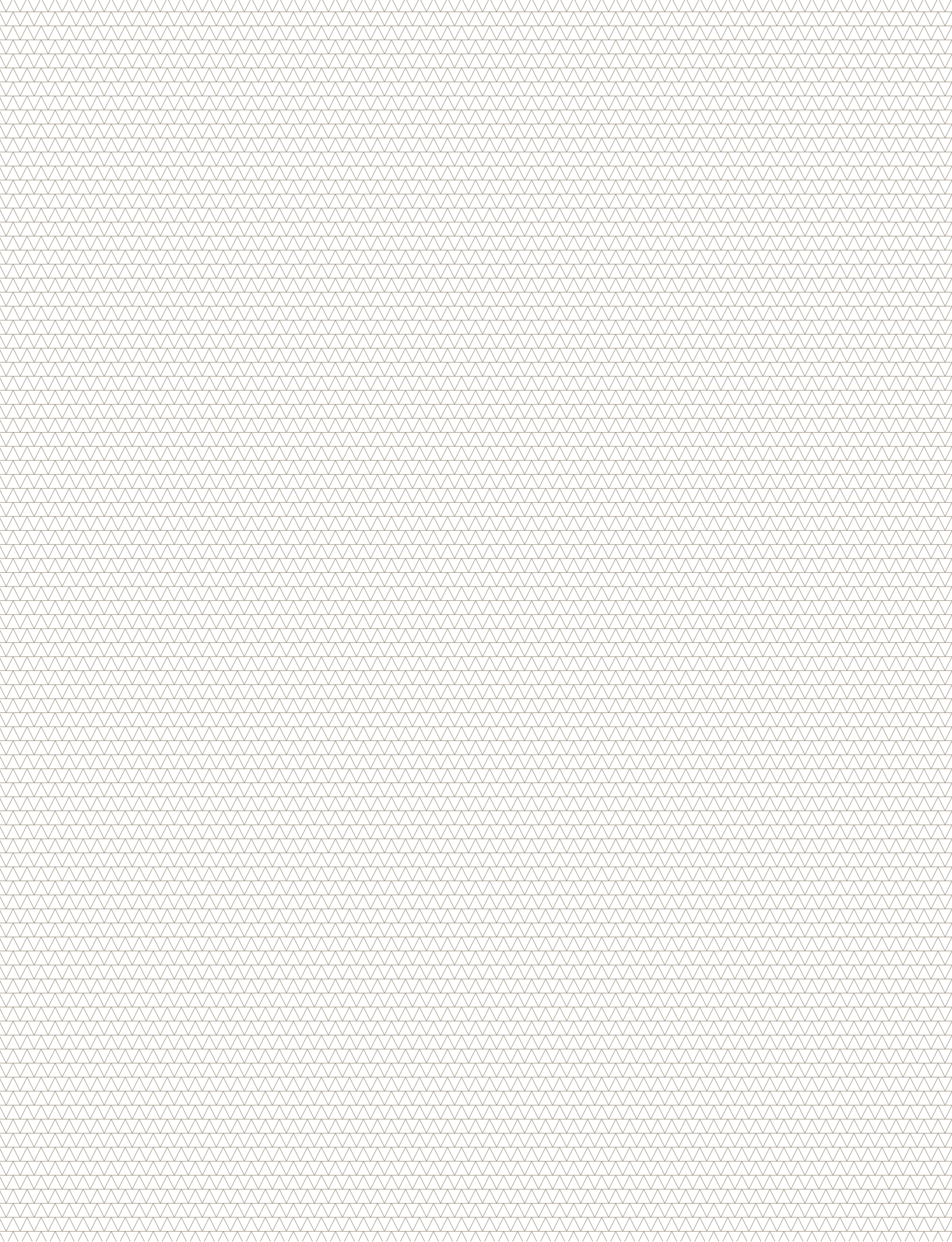

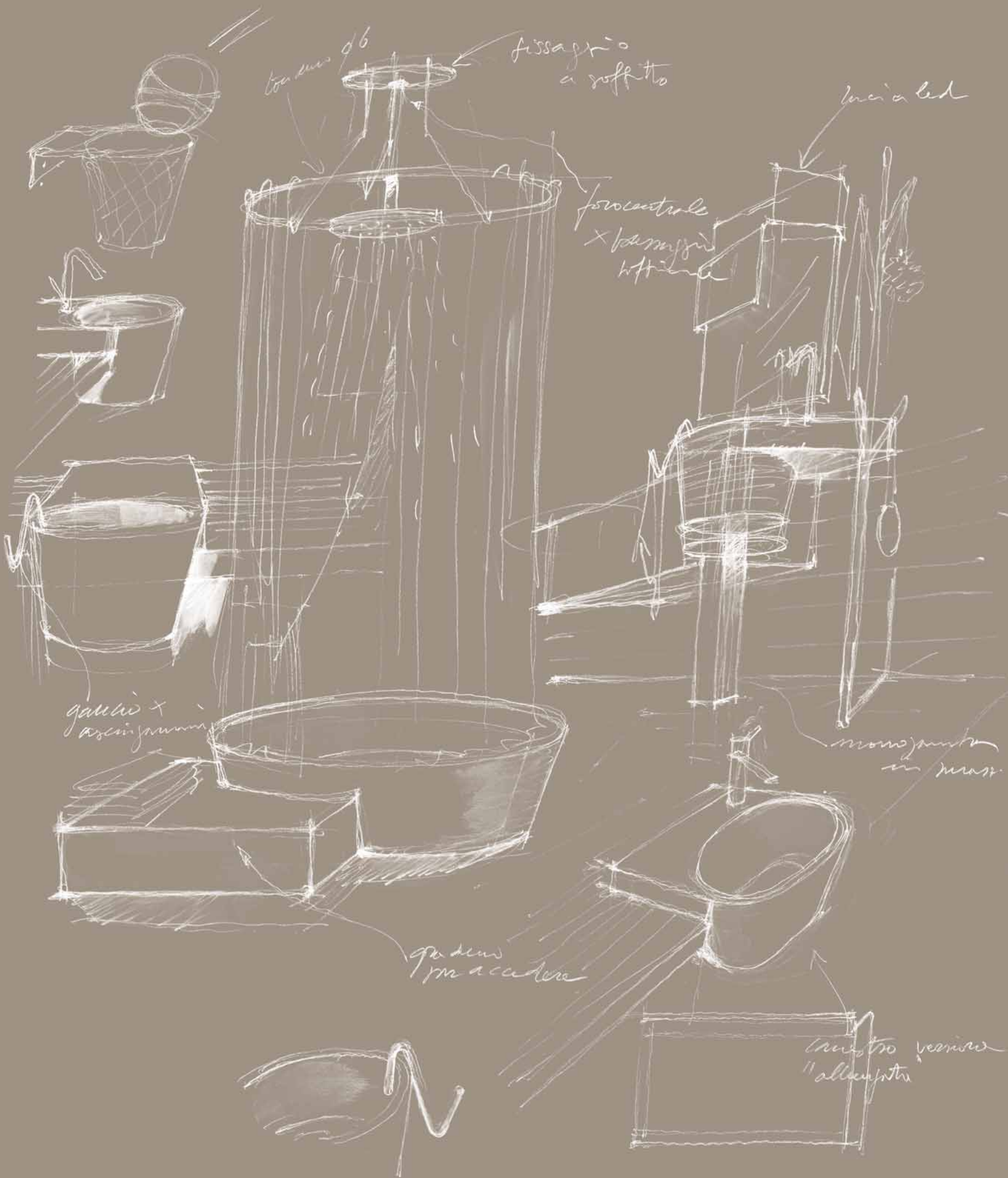

.CANESTRO





La collezione Canestro prende il nome dalla particolare forma del lavabo che ricorda proprio quella di un canestro del gioco del basket. Si tratta di una linea facile, minimale e di design, che si presta ad arredare bagni di ogni dimensione e che offre ampie possibilità di personalizzazione grazie alla modularità e alla varietà dei suoi elementi. Il lavabo, infatti, realizzato in teknorit bianco e comun denominatore della linea, può poggiare su contenitori di misure diverse e laccati in vari colori, ma anche su piani in legno dalla originale finitura a taglio di sega o su cavalletti in massello di rovere dal particolare disegno.

Con la collezione Canestro Novello propone un bagno che va al di là della sua funzione specifica per diventare lo spazio del benessere e del vivere in armonia. Per questo vi sono molti riferimenti al mondo della natura, in particolare nei materiali: viene riscoperto il legno, anche nel suo aspetto tattile, sfruttando lavorazioni che ne esaltano la venatura, lo spessore e il colore. Ma il rimando alla natura è suggerito anche dagli alberi stilizzati in metallo verniciato che completano la linea e che, con i loro rami disposti casualmente, sono utilizzabili per appendere asciugamani o accappatoi.

La palette dei colori si compone di tinte soft e neutre, sfruttando tutta la gamma dal bianco al grigio, passando per il beige, il sabbia e i colori delle terre, ma non manca qualche guizzo di colore squillante. Mentre le finiture scelte sono opache per contribuire ad esaltare le sensazioni materico-tattili.

The Canestro collection takes its name from the particular shape of the wash-basin that reminds one of the basket of the basketball. It is a simple and minimalist design range that furnishes bathrooms of every dimensions. The Canestro range gives you the possibility to personalise your bathroom thanks to its modularity and the variety of its elements. The wash-basin, made of white teknorit and common feature of the collection, can rest on units with different sizes and colours but can also lean on wood tops, with an original "taglio di sega" finish or on trestles made of solid oak wood with a particular design. With the Canestro collection Novello offers a bathroom that goes further than its traditional function. It becomes a source of well-being and harmony. For this reason, there are many references to the nature, in particular in the materials used. The wood is appreciated, also under its tactile aspect, by means of manufacturings that exalt its vein, thickness and colour. The reference to the nature is suggested also by stylised trees in painted metal, the branches of which are to be used to hang towels or bath robes. The palette consists of soft and neutral colours, from white to grey scale, beige, sand and the colours of the earth. However, there are also some flashes of bright colours. All the colours are mat in order to feel better the tactile sensation of the elements.

La collezione Canestro prend le nom de la forme particulière de la vasque qui rappelle justement celle d'un panier du jeu du basket. Il s'agit d'une ligne facile, minimale et de design, qui se prête à meubler des salles de bains de toute dimension et qui offre d'énormes possibilités de personnalisation grâce à la modularité et la variété de ses éléments. En effet, la vasque réalisée en Teknorit blanc et le dénominateur commun de la ligne, peut être poser sur des éléments bas de différentes mesures et laqués en différentes couleurs, mais aussi sur des plans en bois avec la finition originale à « taglio di sega » ou sur des chevalets en rouvre massif avec un dessin particulier. Avec la collection Canestro, Novello propose une salle de bains qui va au-delà de sa fonction spécifique pour devenir l'espace du bien-être et du vivre en harmonie. Pour cela, il ya de nombreuses références à la nature, en particulier dans les matériaux : on redécouvre le bois même dans son aspect tactile en utilisant des procédés qui exaltent la texture, l'épaisseur et la couleur. Mais la référence à la nature est également suggérée par les arbres stylisés en métal laqué qui complètent la ligne et qui, avec leurs branches sans un ordre particulier; sont utilisés pour accrocher les serviettes ou les peignoirs. La palette des couleurs se compose de teintes douces et neutres, en exploitant toute la gamme du blanc au gris, en passant par le beige, le sable et les couleurs des sols, mais il y a aussi des flashes de couleurs vives. Tandis que les finitions choisies sont mates pour contribuer à exalter les sensations tactiles du matériau.

Der Name der Kollektion Canestro bezieht sich auf die besondere Form des Waschbeckens, das an jene des Basketballkorbs erinnert. Es handelt sich hierbei um eine einfache, minimale Linie sowie Design, die sich zum Ausstatten von Badezimmern jeder Größe eignen. Ferner werden dank der Modularität und vielen Bauelemente vielseitige Möglichkeiten für kundenspezifische Lösungen geboten. Das Waschbecken aus weißem Teknorit und allgemeiner Nenner der Linie kann auf Unterschränken mit unterschiedlichen Größen und mit verschiedenen Farben lackiert sowie auf Holztops mit originellen Endfertigungen „Taglio di sega“ (Sägeschnitt) oder auf Massiveiche mit Sonderdesign positioniert werden. Mit der Kollektion Canestro schlägt Novello ein Badezimmer vor, das außer den spezifischen Funktionen, ein Ort des Wohlbefindens und Lebens in Harmonie ist. Aus diesem Grund gibt es viele Hinweise auf die Natur, insbesondere bei den Materialien: das Holz wird neu entdeckt und dies auch bei Berührung, indem die Bearbeitungen ausgenützt werden, welche die Faserrichtung, die Stärke und die Farbe hervorheben. Hinweise auf die Natur sind auch bei den stilisierten Bäumen aus lackiertem Metall zu finden, welche die Linie vervollständigen und die, mit ihren wie zufällig angeordneten Zweigen, auch als Aufhänger für Handtücher und Badezimmermäntel benützt werden können. Die Farbpalette besteht aus angenehmen und neutralen Farbtönen, die alle Farben von Weiß bis Grau bis hin zum Beige sowie Sand- und Erdfarben beinhaltet, wobei auch ein Spritzer greller Farbe nicht fehlt. Die gewählten Feinbearbeitungen hingegen sind matt, um die Sensationen des Materials bei Berührung hervorzuheben.



composizione
C04



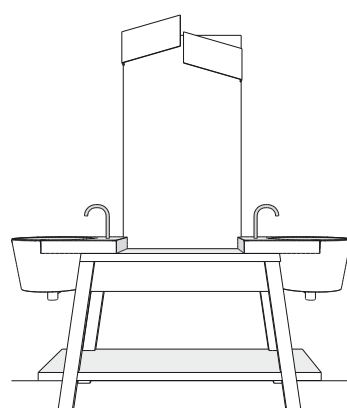

L. 182 x P.42 cm.

Composizione con due lavabi in teknorit bianco dalla originale forma a canestro, appoggiati a sbalzo sopra un doppio cavalletto a giorno realizzato in massello di rovere moro nella finitura a "taglio di sega". Il doppio cavalletto prevede una cassettera centrale ed un piano inferiore per riporre oggetti o asciugamani.

Lo specchio rettangolare è dotato, nella parte alta, di due fasce in acciaio specchiante che diventano dei diffusori di luce indiretta grazie a due lampade a led poste nel loro retro.

I pensili a giorno, in varie dimensioni, sono laccati nelle finiture bianco e melanzana opaco e possono essere installati sia verticalmente che orizzontalmente.

Gli alberi stilizzati in metallo verniciato bianco opaco, con i loro rami disposti casualmente, fungono da appendi asciugamani o accappatoi.

Composition with two twin basket-shaped wash-basins in white teknorit on a trestle made of solid dark wood rovere moro in the "taglio di sega" finish. The trestle has a central drawer and a lower shelf where you can place towels or other objects.

The rectangular mirror has in its upper part two mirrored steel bands, that diffuse the light thanks to two led lights placed on their back side.

The open hanging cabinets, with several dimensions, are lacquered in white and melanzana mat and can be installed both horizontally and vertically.

The branches of the stylised trees in painted white mat metal, are used to hang towels or bath robes.

Composition avec deux vasques en teknorit blanc avec la forme originale du panier posées en saillie sur un double chevalet ouvert réalisé en rovere moro dans la finition à "taglio di sega". Le double chevalet prévoit un tiroir central et un plan inférieur pour mettre des objets ou les serviettes.

Le miroir rectangulaire est muni dans sa partie haute de deux plaques en acier miroitant qui deviennent des diffuseurs de lumière indirecte grâce à deux lampes à led placées derrière les plaques.

Les éléments hauts ouverts, en différentes dimensions, sont laqués dans les finitions blanc et aubergine opaque et ils peuvent être installés aussi bien verticalement qu'horizontalement. Les arbres stylisés en métal laqué blanc mat qui avec leurs branches disposées sans ordre servent de porte serviettes ou peignoirs.

Zusammenstellung mit zwei Waschbecken aus weißem Teknorit mit der originellen Basketballkorbform, überhängend auf einem offenen Doppelständer positioniert, der aus dunkler Massiveiche mit Endfertigung „Taglio di sega“ gefertigt wurde. Der Doppelständer sieht eine mittlere Schublade sowie ein unteres Top für Gegenstände oder Handtücher vor.

Der rechteckige Spiegel ist im oberen Teil mit zwei spiegelnden Stahlbleenden ausgestattet, die dank der zwei Led-Lampen auf der Hinterseite als Verteiler indirekten Lichts dienen.

Die offenen Oberschränke mit verschiedenen Abmessungen sind weiß und in matter Melanzanifarbe lackiert und können sowohl vertikal als auch horizontal montiert werden. Die stilisierten, weiß-matt lackierten Bäume aus Metall können, mit ihren wie zufällig angeordneten Zweigen, auch als Aufhänger für Handtücher und Badezimmermäntel benützt werden.



composizione
C06



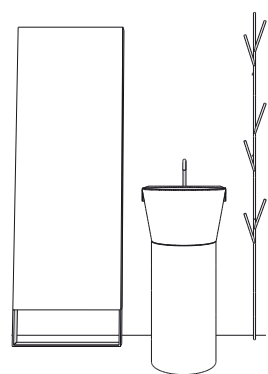

L. 42 x P. 52 cm.

In questa composizione il lavabo in teknorit bianco appoggia su una colonna cilindrica laccata color pietra opaco. Il lavabo finisce con una appendice piatta su cui è ricavato l'alloggio per il rubinetto. Specchio rettangolare a terra da cm. 60 x 180 h con struttura in acciaio specchiante. La collezione Canestro prevede anche delle panche di varie dimensioni nelle finiture rovere ecru – rovere moro – rovere bianco oppure laccate in tutti i colori opachi e lucidi. Completano la composizione dei pensili a giorno di varie forme e dimensioni unitamente a degli specchi. Essi si possono comporre a piacere come gli elementi di un "tangram" a personalizzare una parete o una zona sopra lavello.

In this composition the white teknorit wash-basin rests on a cylindrical column lacquered pietra mat. The wash-basin ends with a flat surface where the tap can be placed. Floor standing rectangular mirror cm. 60 x 180 h with a mirrored steel frame. The Canestro range offers also some benches with several dimensions in rovere ecru, rovere moro, rovere bianco or in all the lacquered colours mat and brilliant. The composition is complemented by some open hanging cabinets with different shapes and dimension and by some mirrors. These mirrors can be arranged as one chooses, like the element of a "tangram" so that a wall or area above the sink can be personalised.

Dans cette composition la vasque en teknorit blanc est posée sur une colonne cylindrique laquée couleur pietra mate. La vasque finit avec une partie plate où il y a le trou pour le robinet. Miroir rectangulaire au sol de cm 60 x 180 h avec structure en acier miroitant. La collection Canestro prévoit aussi des tables basses de différentes dimensions dans les finitions rovere écru - rovere moro - rovere bianco ou laquées dans toutes les couleurs mates et brillantes. Des éléments hauts ouverts de différentes formes et dimensions à des miroirs complètent la composition. Ils peuvent être composés au choix comme les éléments d'un « tangram » pour personnaliser un mur ou une zone sur vasque.

Bei dieser Zusammenstellung befindet sich das Waschbecken aus weißem Teknorit auf einem zylindrischen, matt-pietrafarben lackierten Hochschrank. Das Waschbecken endet mit einem flachen Endteil, wo sich der Sitz für den Wasserhahn befindet. Rechteckiger Spiegel, vom Boden aus cm. 60 x 180 h mit einer Struktur aus spiegelnden Stahl. Die Kollektion Canestro sieht auch Bänke mit verschiedenen Abmessungen mit Endfertigungen aus Rovere ecru - Rovere moro - Rovere bianco in matten und glänzenden Farben vor. Die offenen Oberschränke mit verschiedenen Formen und Abmessungen vervollständigen zusammen mit den Spiegeln das Angebot. Man kann sie je nach Wunsch mit den Zubehören "Tangram" kundenspezifisch auf der Wand oder in einem Bereich über dem Waschbecken zusammenbauen.

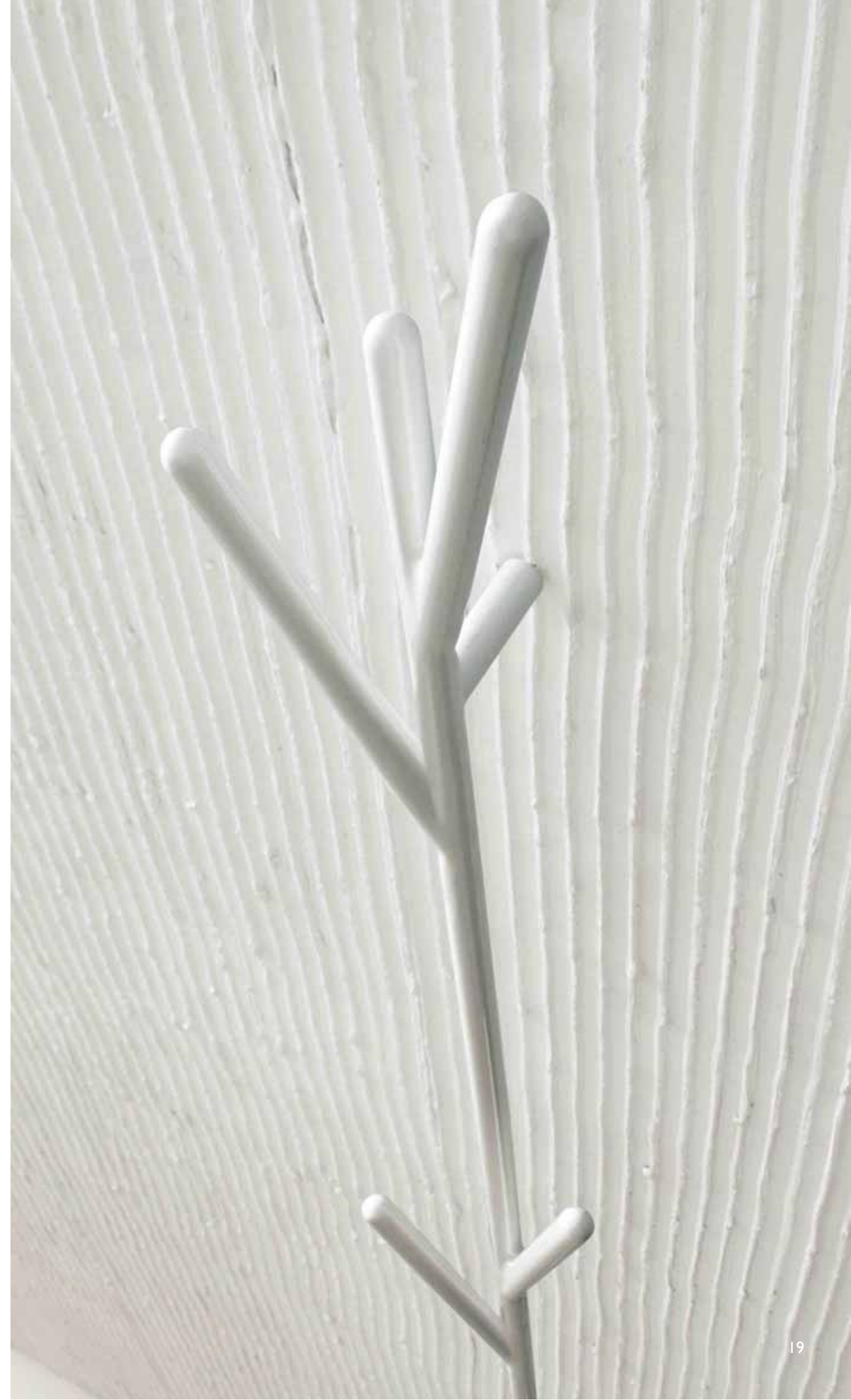

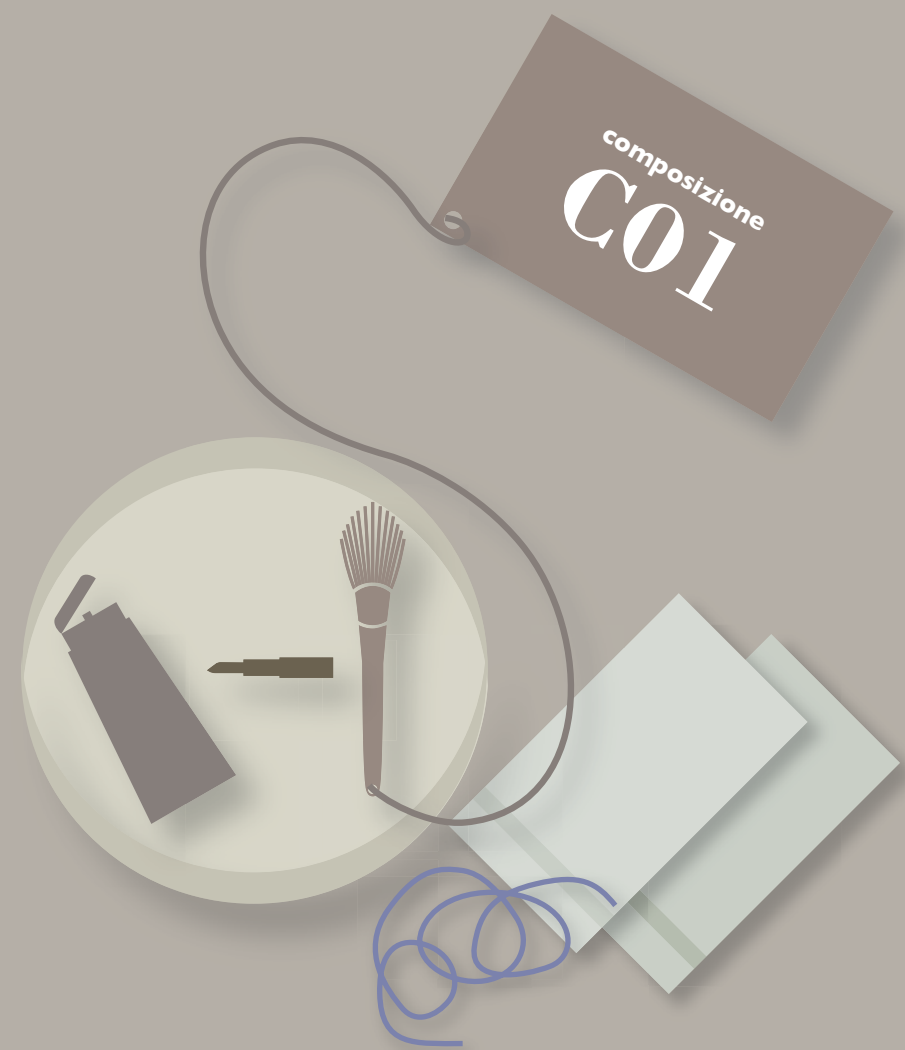

composizione
CO1



composizione
CO1



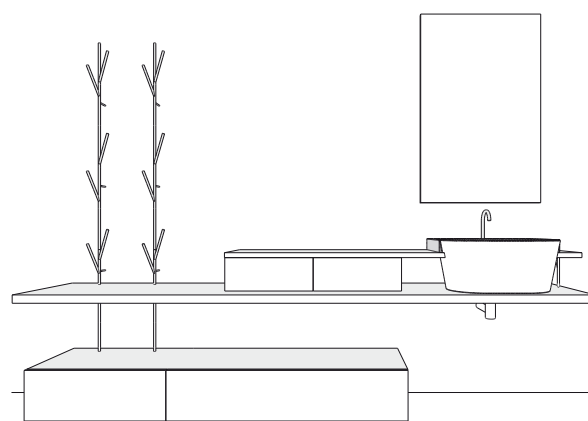

L. 280 x P. 52 cm.

Composizione con top in rovere ecru nella finitura a "taglio di sega" e cassetiere in laccato bianco opaco.
 Il capiente lavabo Canestro in teknorit, nella versione di forma ovale, è largo 62 cm.
 Appendi asciugamani "tree" in metallo verniciato bianco.
 Pratico l'appendino portasciugamani cromato a "S" che si può appoggiare casualmente ai lavabi.

Composition with rovere ecru top with the "taglio di sega" finish and drawer units lacquered white mat.
 The big oval-shaped Canestro wash-basin in teknorit is cm 62 wide.
 Towel holder "tree" in painted white metal.
 The "S-shaped" chromed towel holder is very handy and can be hooked to the wash-basins.

Composition avec plan en rovere écu dans la finition à "taglio di sega" et éléments bas en laqué blanc mat.
 La vasque d'une grande capacité Canestro en teknorit, dans la version de forme ovale, est large 62 cm.
 Porte serviettes en « arbre » en métal laqué blanc.
 Pratique porte gants chromé en « S » que l'on peut accrocher aux vasques où on veut.

Zusammenstellungen mit Tops aus Rovere ecru mit Endfertigung „Taglio di sega“ sowie matt-weiß lackierter Unterschränke.
 Das große Waschbecken Canestro aus Teknorit in ovaler Ausführung ist 62 cm breit.
 Aufhänger für Handtücher "Tree" aus weißlackiertem Metall.
 Der praktische s-förmige, verchromte Aufhänger für Handtücher kann auf den Waschbecken positioniert werden.



composizione
C02



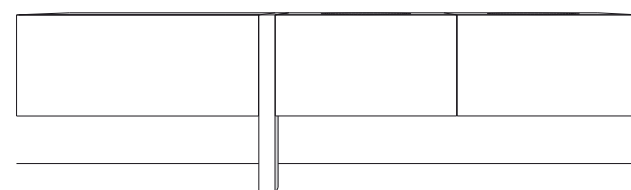
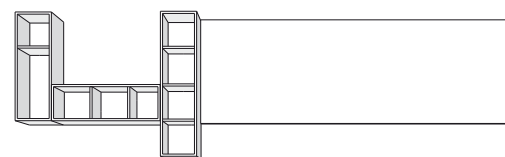

L. 308 x P. 42 cm.

Composizione laccata pietra opaco con piano lavabo integrato in cristallo satinato colore pietra extrachiaro.
Specchio da cm. 180 x 50 con lampada alogena.
Le basi sono dotate di ampio cassettone con secondo cassetto interno.
Particolare della gamba supporto in rovere ecru in finitura "a taglio di sega".
Il lavabo integrato in cristallo è stato realizzato nella ridotta profondità 42 cm.

Composition lacquered pietra opaco, integrated satin crystal top colour pietra extrachiaro. Mirror cm 180 x 50h with halogen lamp.
The cabinets are equipped with a big drawer and a second internal drawer.
Detail of the supporting leg in rovere ecru with the "taglio di sega" finish.
The integrated crystal wash-basin top is made in the reduced depth cm 42.

Composition laquée pietra mate avec plan-vasque moulée en cristal satiné couleur pietra extra-clair. Miroir de 180 x 50 cm avec lampe halogène.
Les éléments bas sont munis d'un grand tiroir avec un deuxième tiroir intérieur.
Détail du pied de soutien en rovere écru en finition à "taglio di sega".
La vasque moulée en cristal a été réalisée dans la profondeur réduite 42 cm.

Pietrafarbenlackierte, matte Zusammenstellung mit integriertem WT-Top aus satinierem, pietrafarbenen, extrahellem Kristall. Spiegel von 180 x 50 cm mit Halogenlampe.
Die Unterschränke sind mit großen Schubladen und einer zweiten, internen Schublade ausgestattet.
Detail des Stützfußes aus Rovere ecru mit Endfertigung „Taglio di sega“.
Das integrierte Top aus Kristall wurde mit einer reduzierten Tiefe von 42 cm gefertigt.





composizione
C03



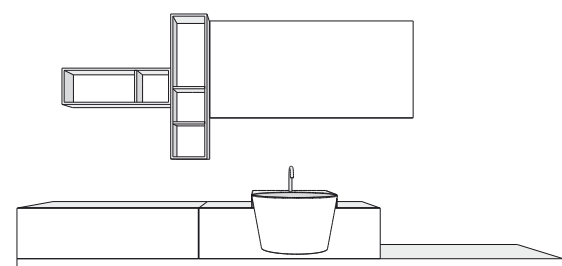

L. 280 x P. 52/37 cm.

Lavabo in teknorit bianco dalla originale forma a canestro appoggiato su piano in legno di rovere moro con lavorazione a "taglio di sega" di spessore 4 cm e nella profondità 35 cm.

Contenitori a cassetti da cm. 90 x 37 x 25 h. laccati sabbia opaco, specchio con struttura in acciaio specchiante, contenitori modulari a giorno laccati nelle finiture bianco e grigio chiaro opaco, appendi asciugamano "tree" in metallo verniciato bianco.

I pensili a giorno sono laccati nelle finiture bianco e grigio chiaro opaco, possono essere installati sia verticalmente che orizzontalmente.

Lo specchio, con struttura in acciaio specchiante, sopra il lavabo da cm. 120 x 60 h. è completato da una lampada a led.

Wash-basin in white teknorit with the original canestro-shape on a rovere moro top with the "taglio di sega" finish thickness 4 cm, depth 35 cm.

Drawer units cm 90 x 37 x 25h, lacquered sabbia mat, mirror with a mirrored steel frame, modular open hanging cabinets lacquered white and grigio chiaro mat, towel holder "tree" in painted white metal.

The open hanging cabinets are lacquered in white and grigio chiaro mat and can be installed both horizontally and vertically.

The mirror above the wash-basin is cm 120 x 60 h., has a mirrored steel frame and a led light.

Vasque en teknorit blanc avec la forme originale à panier posée sur un plan en bois de rovere moro avec usinage à "taglio di sega" d'épaisseur 4 cm et dans la profondeur 35 cm.

Éléments bas avec tiroirs de cm 90 x 37 x 25 h laqués sable mat, miroir avec structure en acier miroitant, éléments bas modulaires ouverts laqués dans les finitions blanc et gris clair mat, porte peignoir-serviette en "arbre" en métal laqué blanc.

Les éléments hauts ouverts sont laqués dans les finitions blanc et gris clair mat, ils peuvent être installés aussi bien verticalement qu'horizontalement. Le miroir, avec une structure en acier miroitant, sur la vasque de cm 120 x 60 h est complet d'une lampe à led.

Washbecken aus weißem Teknorit mit origineller Basketballkorbform auf einem Holz-Top aus Rovere moro mit einer Stärke von 4 cm und einer Tiefe von 35 cm.

Die Unterschränke von cm 90 x 37 x 25 h sind sabbiafarben-weiß lackiert, Spiegel mit einer spiegelnden Stahlstruktur, modulare offene Unterschränke, die Endfertigungen sind weiß und matt-grigio chiaro lackiert, Aufhänger für Handtücher "Tree" aus weißlackiertem Metall.

Die offenen Oberschränke besitzen weiß und matt-grigio chiaro lackierte Endfertigungen und können sowohl vertikal als auch horizontal montiert werden.

Der Spiegel oberhalb des Waschbeckens mit den Abmessungen cm 120 x 60 h mit einer spiegelnden Stahlstruktur kann mit einer Led-Lampe ausgestattet werden.





composizione
C05





P

47

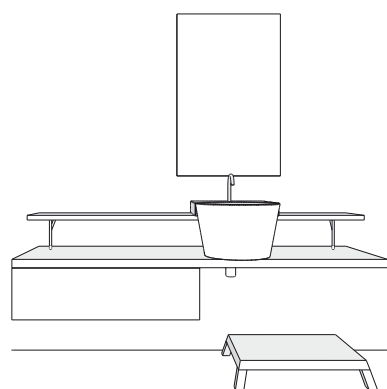

L. 180 x P. 52 cm.

Composizione con tops e cassetteria in rovere ecru nella finitura a "taglio di sega". Lavabo Canestro in teknorit. Specchio da cm. 70 X 110 h, con lampada fluorescente.

Il lavabo è completato da un pratico portasciugamani cromato a forma di gancio.

Composition with tops and drawer unit rovere ecru with the "taglio di sega" finish. Canestro wash-basin in teknorit. Mirror cm 70 X 110 h, with fluorescent lamp.

On the wash-basin there is a useful chromed towel-holder, hook-shaped.

Composition avec plans et élément bas en rovere écru dans la finition à "taglio di sega". Vasque Canestro en teknorit. Miroir de cm 70 X 110 h avec lampe fluorescente.

La vasque est complétée d'un porte-gants chromé en forme de crochet.

Zusammenstellungen mit Tops und Schubladen aus Rovere ecru mit Endfertigung „Taglio di sega“. Das Waschbecken Canestro aus Teknorit. Spiegel mit den Abmessungen 70 X 110 h mit Leuchtstofflampe.

Das Waschbecken besitzt einen praktischen, verchromten, hakenförmigen Aufhänger für Handtücher.



P



composizione
C07

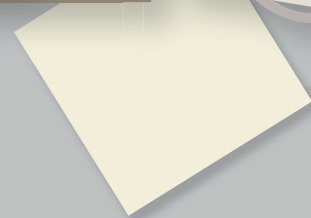

composizione
C07



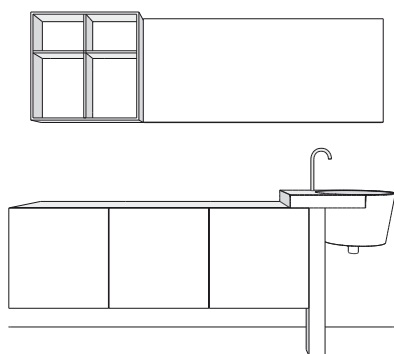

L. 184 x P.42 cm.

Composizione in rovere bianco nella finitura a "taglio di sega" con lavabo canestro in teknorit appoggiato ad una gamba laterale sempre in rovere bianco. Specchio da cm. 120 x 60 h. e pensile a giorno da cm. 60 x 60 h. Gli elementi contenitori sono a cassetti.

Composition in rovere bianco with the "taglio di sega" finish, Canestro wash-basin in teknorit on a rovere bianco leg. Mirror cm. 120 x 60 h. and open hanging cabinet cm. 60 X 60 h. The cabinets are with drawers.

Composition en rovere bianco dans la finition à "taglio di sega" avec vasque Canestro en teknorit posée à un pied latéral en rovere bianco aussi. Miroir de cm 120 x 60 h et élément haut ouvert de cm 60 x 60 h. Les éléments bas sont avec tiroirs.

Zusammenstellung aus Rovere bianco mit Waschbecken Canestro aus Teknorit auf einem seitlichen Stützfuß aus Rovere bianco aufliegend. Spiegel mit den Abmessungen cm 120 x 60 h und offener Oberschrank von cm 60x60 h. Bei den Ladenelementen handelt es sich um Schubladen.



composizione
C08



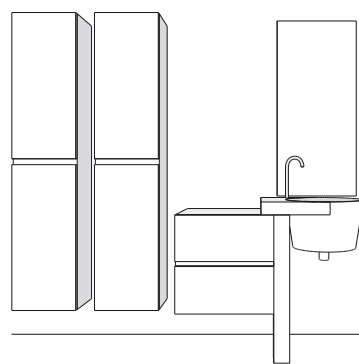

L. 94 x P. 42 cm.

Lavabo Canestro in teknorit da cm. 42 appoggiato su gamba in rovere ecru nella finitura a "taglio di sega".
Cassetiera bianco opaco. Specchio da cm. 45 x 110 h.

Canestro wash-basin in teknorit cm 42, on a rovere ecru leg with the "taglio di sega" finish.
Drawer unit white mat. Mirror cm 45 x 110 h.

Vasque Canestro en teknorit de 42 cm posée sur pied en rovere écru dans la finition à "taglio di sega". Éléments bas blanc mat. Miroir de cm 45 x 110 h.

Washbecken Canestro aus Teknorit mit den Abmessungen 42 cm auf einem Stützfuß aus Rovere ecru mit Endfertigung „Taglio di sega“ aufliegend. Matt-weißer Unterschrank Spiegel mit den Abmessungen cm 45 x 110 h.

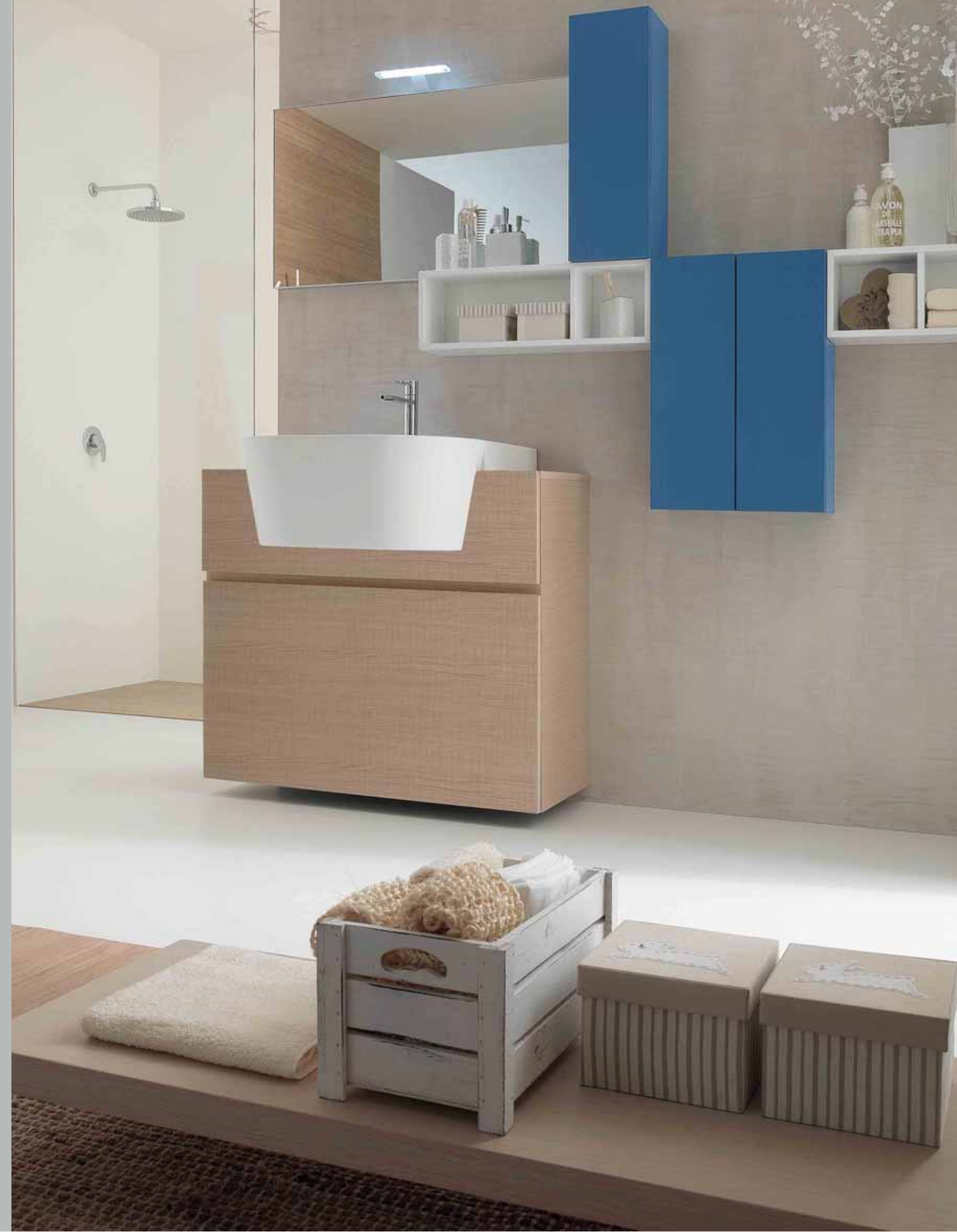

composizione
C14



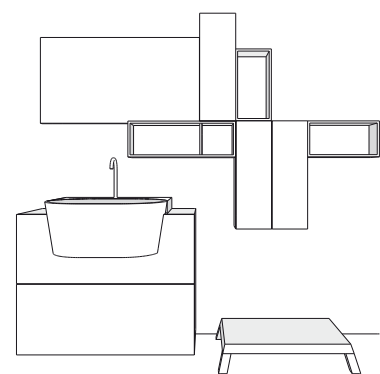

L. 90 x P. 52/37 cm.

Base portlavabo in rovere ecru nella finitura a "taglio di sega" con cassetto.
 Lavabo Canestro in teknorit, larghezza cm. 62.
 Specchio con lampada a led.
 Pensili con anta apertura a scatto.

Wash-basin cabinet with drawer in rovere ecru with the "taglio di sega" finish.
 Canestro wash-basin in teknorit, cm 62 wide.
 Mirror with led light.
 Hanging cabinets with push-pull opening.

Bas sous-vasque en rovere écreu dans la finition à "taglio di sega" avec tiroir.
 Vasque Canestro en teknorit largeur 62 cm.
 Miroir avec lampe à led.
 Éléments hauts avec porte ouverture push-pull.

WT-Unterschrank aus Rovere ecru mit Endfertigung „Taglio di sega“ und Ladenelement.
 Waschbecken Canestro aus Teknorit, Breite 62 cm.
 Spiegel mit Led-Lampe.
 Oberschränke mit Einrasttür.

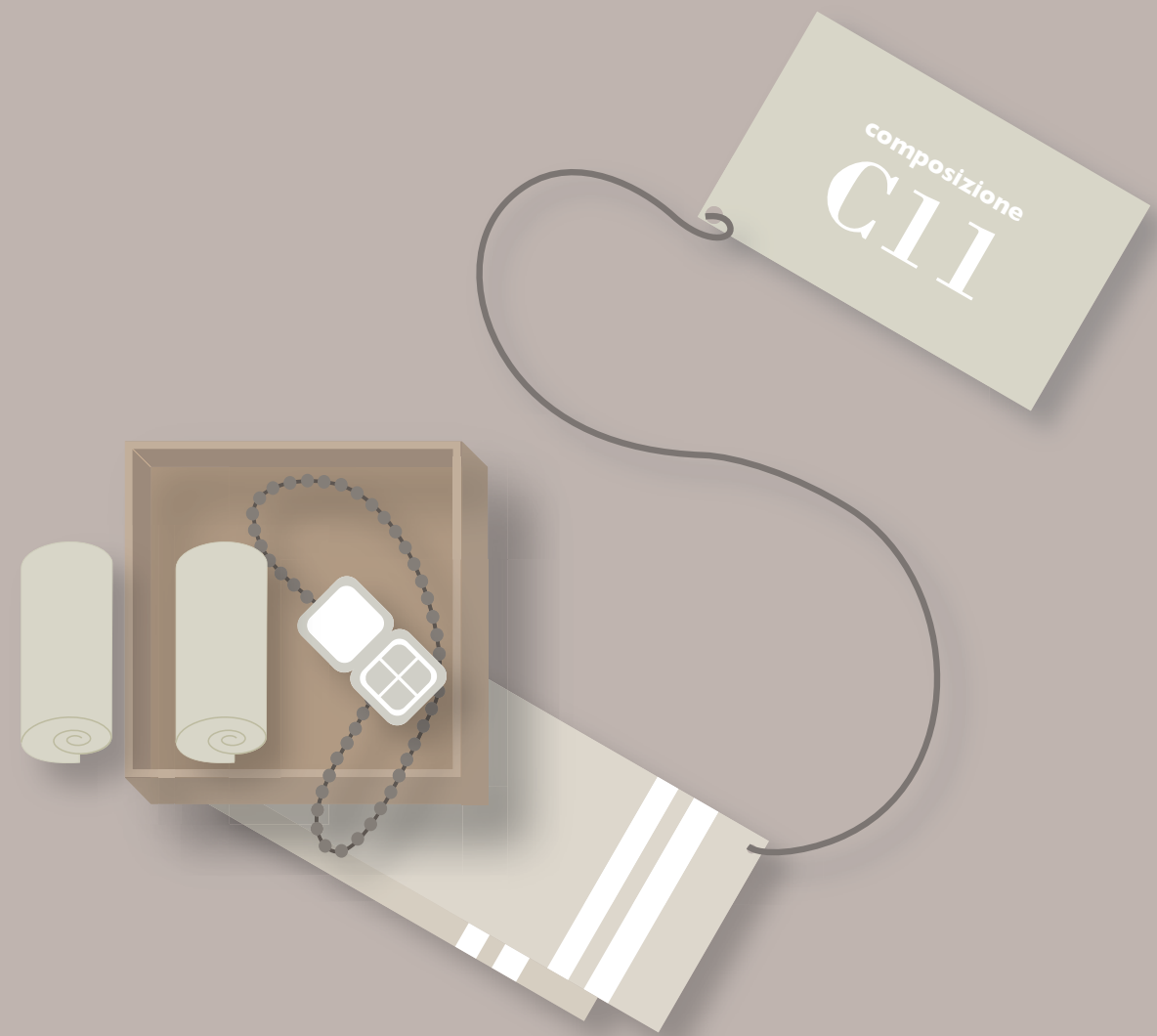



composizione
C11





A

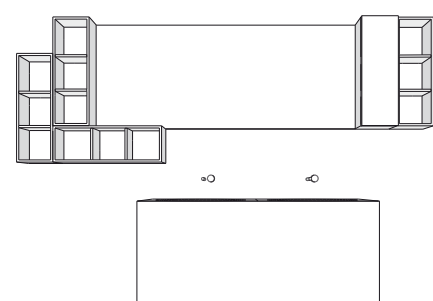

L. 120 x P. 42 cm.

Base portlavabo nel colore pietra opaco con piano integrato doppio lavabo in cristallo colore pietra extrachiario.

Wash-basin cabinet colour pietra opaco, double integrated crystal wash-basin colour pietra extrachiario.

Bas sous-vasque dans la couleur pietra mate avec plan-vasque moulée double vasque en cristal couleur pietra extra-clair.

Pietrafarben-matter WT-Unterschrank mit integriertem Doppelwaschbecken aus Kristall, pietrafarben extrahell.

composizione
CI1





composizione
C09



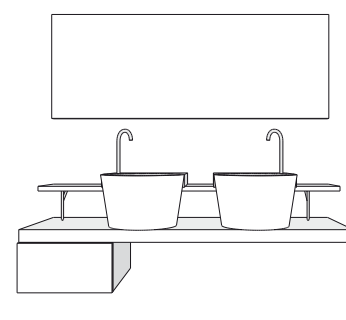

L. 160 x P. 52 cm.

Composizione con due lavabi Canestro da cm. 42 in teknorit.
 Piani d'appoggio in laccato grigio scuro opaco e cassetteria da cm. 45 in laccato bianco opaco.
 Specchio da cm. 160 x 60 h. con due lampade a led.
 Particolare del supporto cromato per il sostegno del top superiore.
 Pensili a giorno o con anta con apertura push-pull.
 Piatto doccia Canestro rotondo diametro cm. 90 in teknorit bianco con gradino angolare. Tenda in "tessuto vela" con supporto circolare cromato.

Composition with two wash-basins Canestro in teknorit, cm 42.
 Tops lacquered grigio scuro opaco and drawer unit cm 45 lacquered white mat.
 Mirror cm 160 x 60 h with two led lights.
 Detail of the chromed support to hold the upper top up.
 Open hanging cabinet or with door with push-pull opening.
 Canestro round shower tray with step, diameter cm 90 in white teknorit.
 Curtain made of sailcloth with circular chromed support.

Composition avec deux vasques Canestro de cm 42 en teknorit. Plans d'appui en laqué grigio scuro mat et élément bas de 45 cm en laqué blanc mat.
 Miroir de cm 160 x 60 h avec deux lampes à led.
 Détail du support chromé pour le soutien du plan supérieur.
 Éléments hauts ouverts ou avec porte ouverture push-pull.
 Bac à douche Canestro rond diamètre 90 cm en teknorit blanc avec une marche angulaire. Rideau de douche en « tissu voile » avec tringle circulaire chromé.

Zusammenstellung mit zwei Waschbecken Canestro mit den Abmessungen 42 cm aus Teknorit. WT-Unterschranke grigio scuro-matt lackiert und Ladenelement von 45 cm, matt-weiß lackiert.
 Spiegel mit den Abmessungen cm 160 x 60 h mit zwei Led-Lampen.
 Detail des verchromten Supports zur Stütze des oberen Tops.
 Offene Oberschränke oder-Tür mit Push Pull-Öffnung.
 Runde Duschwanne Canestro mit einem Durchmesser von 90 cm aus weißem Teknorit mit gewinkelter Stufe. Duschvorhang aus "Segelgewebe" mit rundem, verchromtem Support.



composizione
C12



composizione
C15



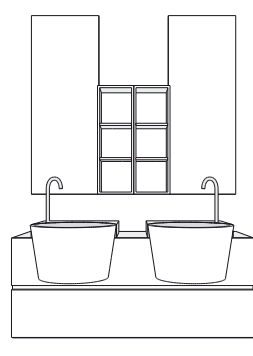

L. 120 x P. 52/37 cm.

Base portlavabo con cassetto prof. 37,5, con due lavabi Canestro in tekno-rit. Colore rovere ecru nella finitura a "taglio di sega". Pensili a giorno laccati opaco, larghi 20 cm. Specchi da cm. 40 x 110 h, con lampade a led.

Wash-basin cabinet with drawer with two Canestro wash-basins in tekno-rit. Depth cm 37,5, colour rovere ecru with the "taglio di sega" finish. Open hanging cabinets mat lacquered, 20 cm wide. Mirror cm 40 x 110 h with led lamps.



89

Bas sous-vasque avec tiroir prof. 37,5 avec deux vasques Canestro en tekno-rit. Couleur rovere ecru dans la finition à "taglio di sega". Éléments hauts ouverts laqués mats, largeur 20 cm. Miroirs de cm 40 x 110 h avec lampes à led.

WT-Unterschrank mit Schublade, Tiefe 37,5 mit zwei Waschbecken Canestro aus Tekno-rit. Farbe Rovere ecru mit Endfertigung „Taglio di sega“. Offene Oberschränke matt lackiert, Breite 20 cm. Spiegel mit Abmessungen cm 40x110 h und Led-lampen.

composizione
C13

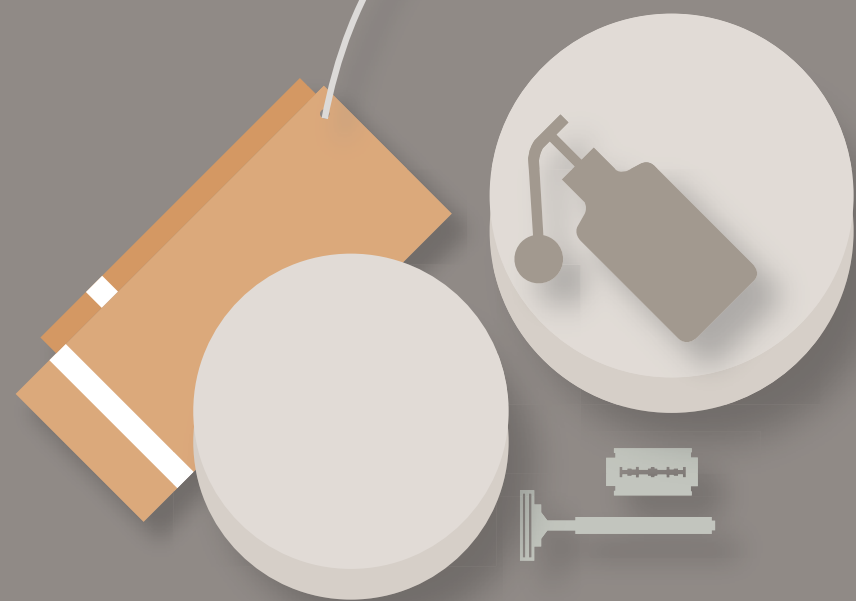

composizione
C13



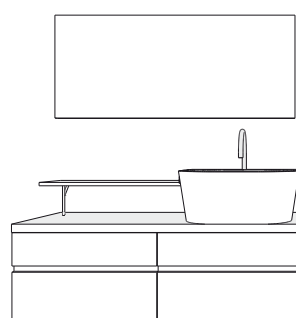

L. 140 x P. 52 cm.

Composizione in rovere moro nella finitura a "taglio di sega" con cassettiere prof. 50 e lavabo Canestro ovale da cm. 62.
Specchio da cm. 140 x 60 h, con lampada a led. Colonne a giorno e con anta prof. cm 21.

Composition in rovere moro with the "taglio di sega" finish with drawer units cm 50 deep and oval Canestro wash-basin cm 62 wide.
Mirror cm 140 x 60 h with led light. Open and closed with door columns depth cm 21.

Composition en rovere brun dans la finition à "taglio di sega" avec élément bas prof. 50 et vasque Canestro ovale de 62 cm.
Miroir de cm 140 x 60 h avec lampe à led. Colonnes ouvertes et avec porte prof. 21 cm.

Zusammenstellung aus Rovere moro mit Endfertigung „Taglio di sega“ und Unterschrank mit einer Tiefe von 50 und rundes Waschbecken Canestro von 62 cm.
Spiegel mit Abmessungen cm 140 x 60 h mit Led-Lampe. Offene Hochschränke mit Tür; Tiefe 21 cm.

ALTRI ESEMPI DI COMPOSIZIONI

Other examples of compositions Des autres exemples de composition Andere Beispiele zum Zusammenbau

composizione
C16

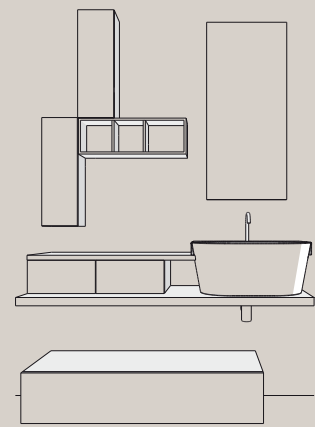

L. 140 x P. 52 cm.

composizione
C19

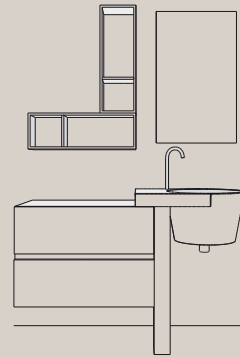

L. 120 x P. 42 cm.

composizione
C17

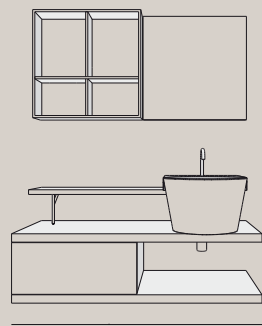

L. 120 x P. 52 cm.

composizione
C20

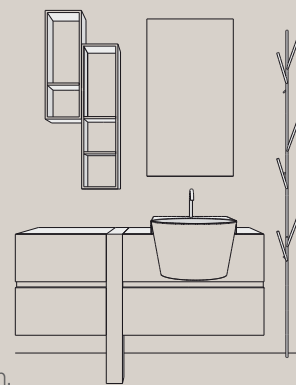

L. 123 x P. 52/37 cm.

composizione
C18

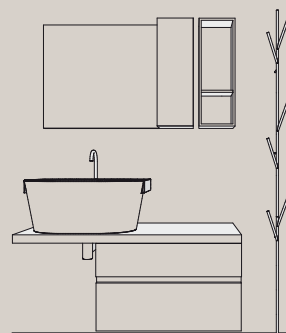

L. 120 x P. 52 cm.

composizione
C21

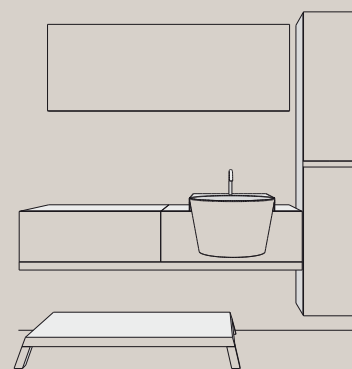

L. 175 x P. 52/37 cm.



.LE ESSENZE

Wood Les coloris bois Die Holzfarben



Rovere bianco



Rovere ecrù



Rovere moro

.I COLORI LACCATI OPACHI E LUCIDI

Lacquered glossy and mat colours Les couleurs laquées brillantes et mates Die glänzend und matt lackierten Farben



Bianco



Avorio



Sabbia



Giallo cedro



Rosa chiaro



Rosa shocking



Arancio



Rosso



Rosso amaranto



Zucca



Terra



Ocra



Pietra



Caffè



Verde chiaro



Verde menta



Verde acido



Azzurro cielo



Lavanda



Melanzana



Violetto



Blu acciaio



Blu orizzonte



Blu avio



Grigio chiaro



Grigio scuro



Nero



Oro



Grigio metallizzato

.I COLORI DEI TOP IN CRISTALLO

Colours of crystal tops Les couleurs des plans en cristal Die Farben der Top aus Kristall

Cristalli extrachiarissimi sp. 10 mm.



Bianco



Avorio



Sabbia



Arancio



Rosso

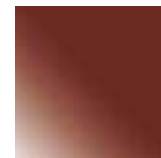

Rosso amaranto

Extrahelles Kristallglas th. 10 mm.



Zucca



Terra



Pietra



Caffè



Melanzana



Violetto

Cristal extra-clair ép. 10 mm.

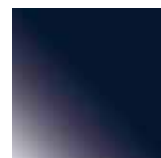

Blu acciaio



Blu orizzonte



Grigio chiaro



Grigio scuro



Nero

Extrahelles Kristallglas St. 10 mm.

Progetto grafico: Högne & Platz Design

Fotografia: Lazzari Forma 3

Art buyer: Patrizia Toffolo

Fotolito: Grafiche Vianello srl

Stampa: Grafiche Vianello srl

Febbraio 2011

